













INSTRUCCIONES DE MONTAJE - MOUNTING INSTRUCTIONS - MONTAGEANLEITUNG

KIT REFUERZO CÚPULA - SCREEN REINFORCEMENT KIT FOR - SCHEIBENVERSTÄRKUNG FÜR
BMW R1200GS LC / LC ADVENTURE
R1250GS



ID	PIEZA / PART	DESCRIPCIÓN	DESCRIPTION	QTY	REF.
1		Soporte derecho fijo	Right fixed support	1	SOPOR4P-10-7566
2		Soporte derecho guía	Right guided support	1	SOPOR4P-10-7566
3		Soporte izquierdo fijo	Left fixed support	1	SOPOR4P-10-7566
4		Soporte izquierdo guía	Left guided support	1	SOPOR4P-10-7566
5		Casquillo interior Ø int. 8,2 x 9'8 x 5mm (negro)	Cylinder Ø inner 8,2 x Ø outer 9'8 x 5mm (black)	2	CASQUI-2----572
6		Casquillo exterior Ø int. 10 x 12 x 3,2mm (negro)	Cylinder Ø inner 10 x Ø outer 12 x 3,2mm (black)	2	CASQUI-2----572
7		Arandela de Nylon DIN 433 Øint. 10,5 x Øext. 18 x 1,6mm	Nylon Washer DIN 433 Øinner 10,5 x Øouter 18 x 1,6mm	2	ARAND-----650
8		Arandela metálica M8x1,5mm DIN125 (negro)	M8x1,5 DIN125 metal washer (black)	2	ARANDPD125A-018
9		Tuerca M8 Autoblocante (negro)	M8 locknut (black)	2	TUEA-D985.8-M8-
10		Tapón tuerca (negro)	Nut cover (black)	2	CAPERUTM8--21/2
11		Tornillo M5x16 Ø11 ISO 7380 (negro)	M5x16 Ø11 ISO 7380 screw (black)	2	TORNI-I7380-493
12		Tornillo M6x25 ISO 7380 (negro)	M6x25 ISO 7380 screw (black)	4	TORNI-I7380-405
13		Arandela metálica M6x1mm (negro)	M6x1mm metal washer (black)	4	ARANDEPD125-054
14		Casquillo Ø int. 8 x Ø ext. 14x7,5 (negro)	Cylinder Ø inner 8 x Ø outer 14x7,5 (black)	4	CASQUI8147-0193

SIN SOPORTE GPS / WITHOUT GPS SUPPORT

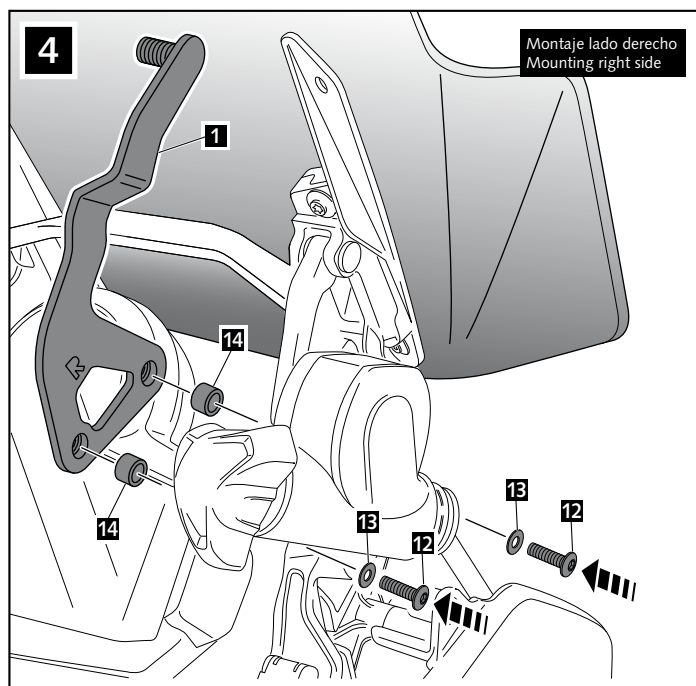
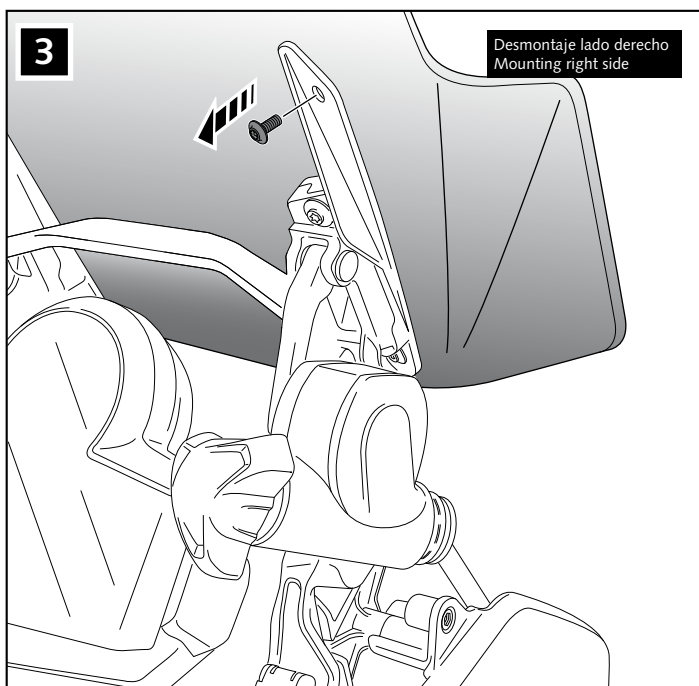
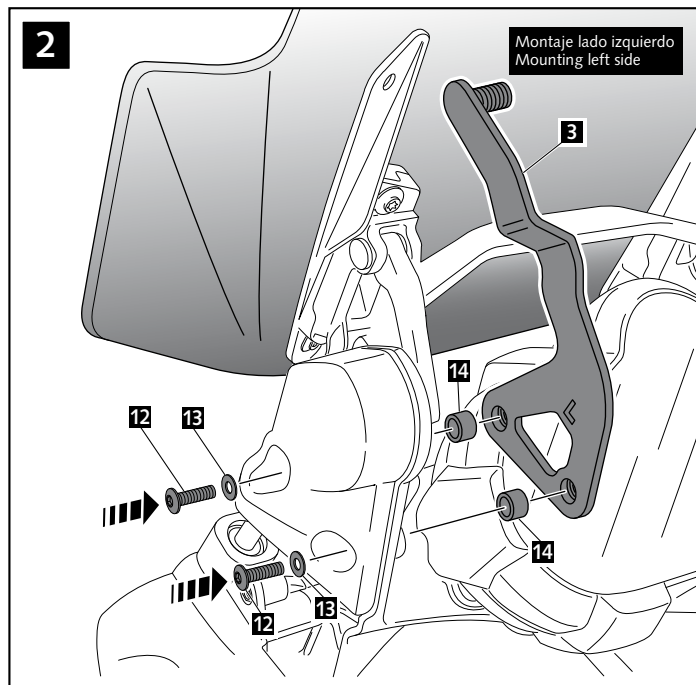
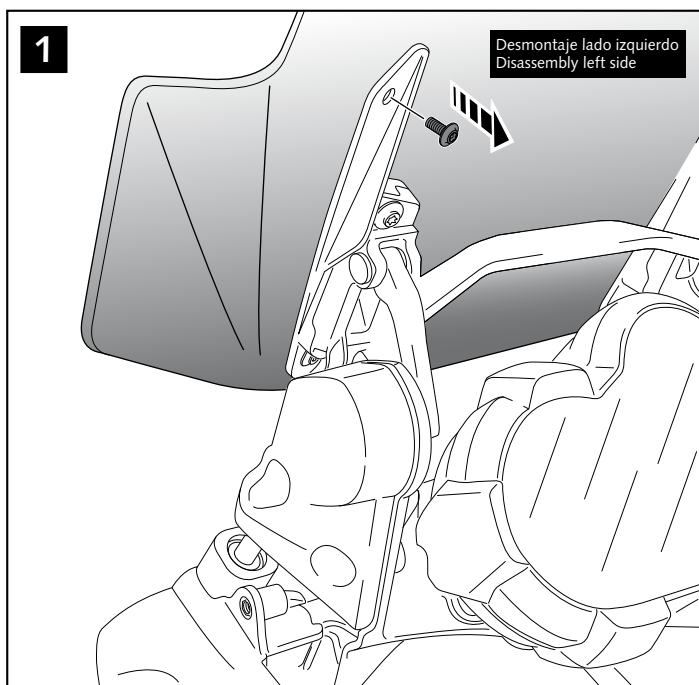

CON SOPORTE GPS / WITH GPS SUPPORT

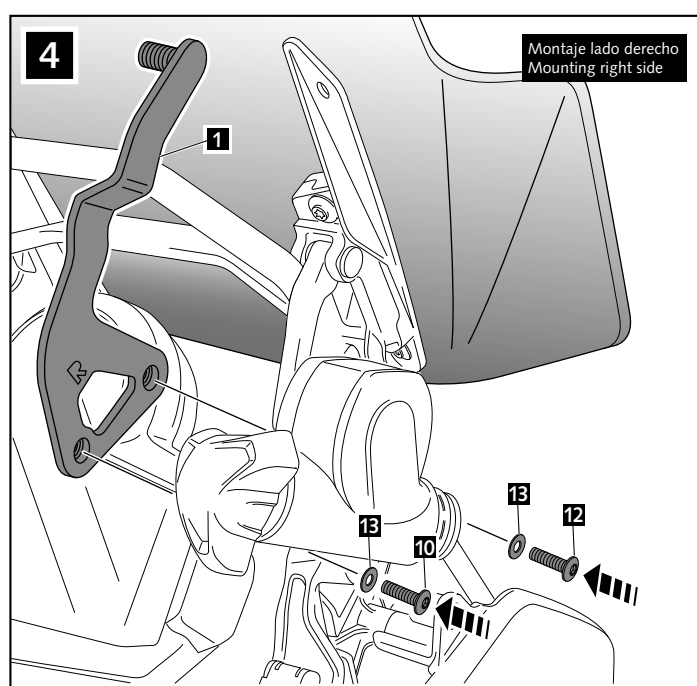
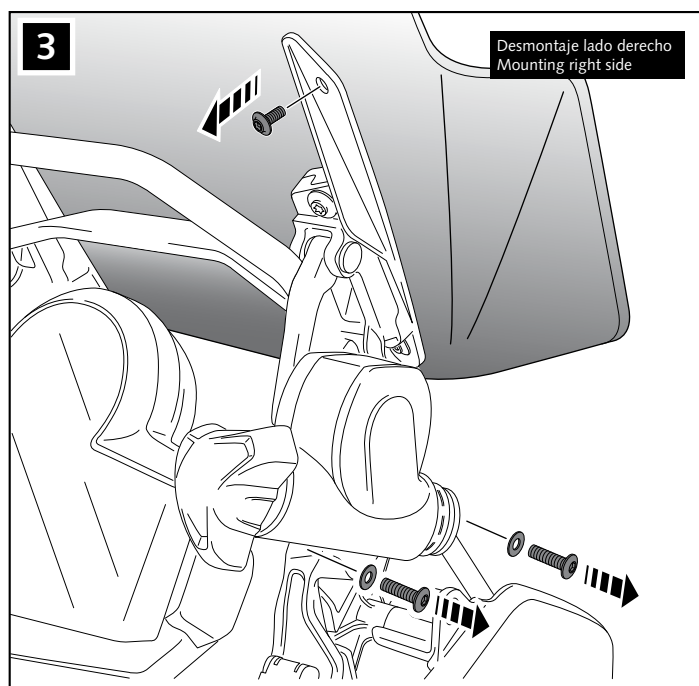
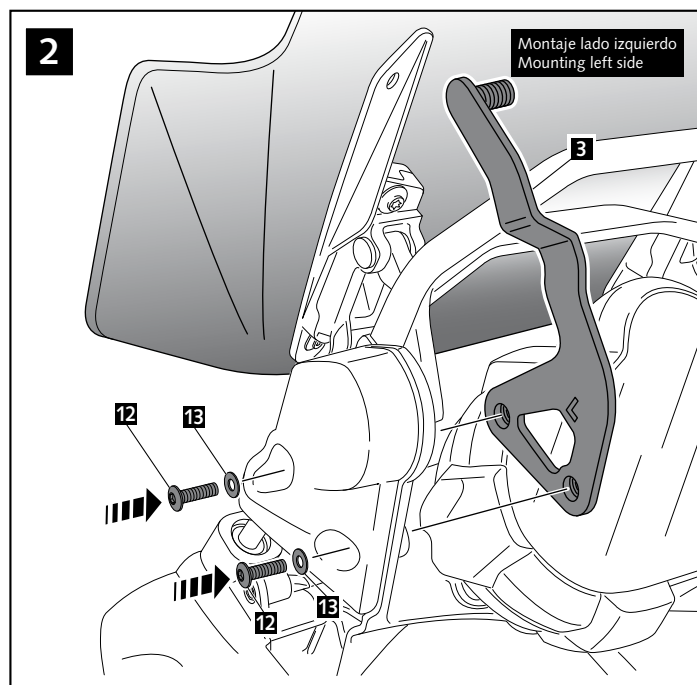
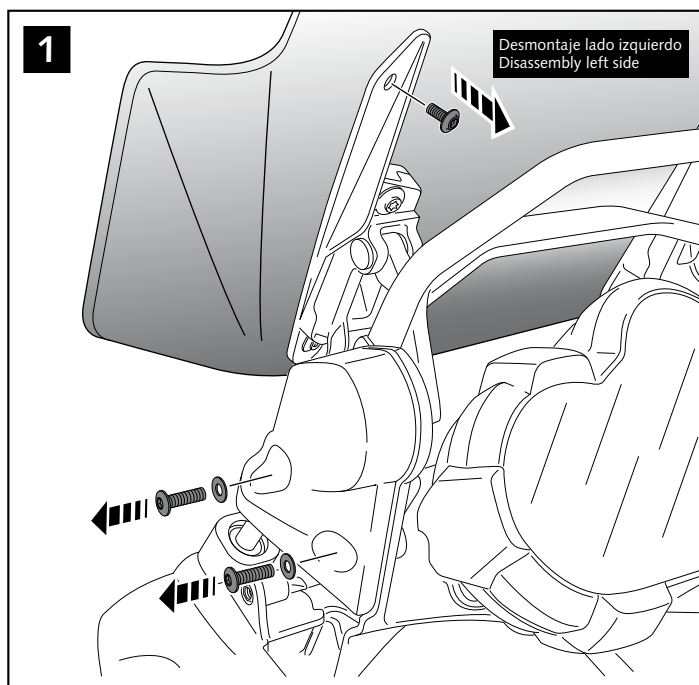

CON Y SIN SOPORTE GPS / WITH & WITHOUT GPS SUPPORT

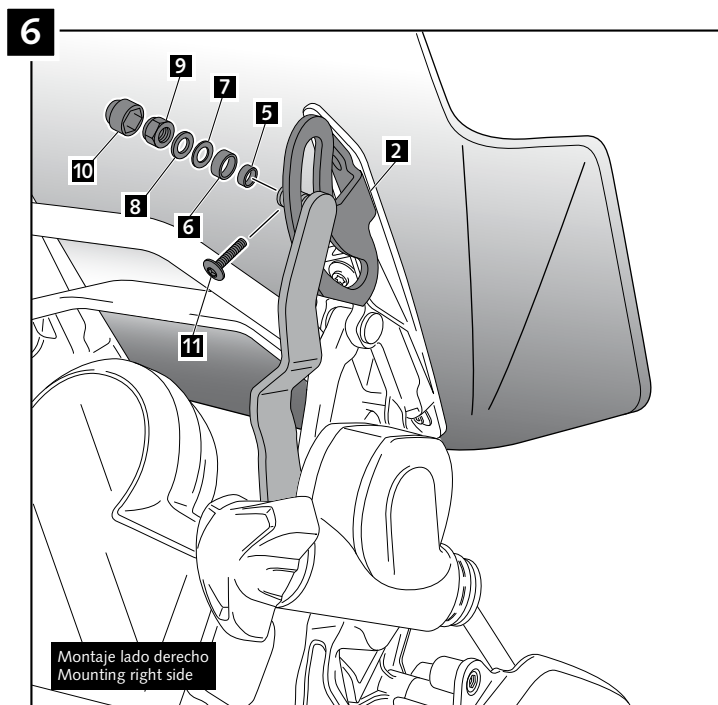
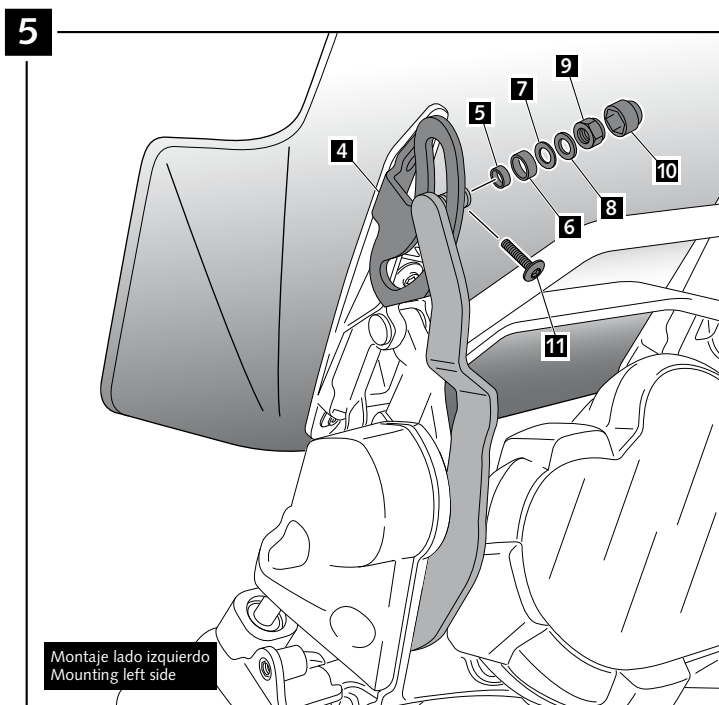

INSTRUCCIONES DE USO / USAGE INFORMATION

EL SOPORTE REFUERZO DISEÑADO POR **PUIG**, APORTA UNA RIGIDEZ EXTRAORDINARIA AL CONJUNTO DE LA CÚPULA. UNA VEZ MONTADO Y A DIFERENCIA DE OTROS SISTEMAS, NO ES NECESARIO AFLOJAR LA TUERCA PARA MOVER LA CÚPULA. ESTE MECANISMO ESTA DISEÑADO PARA QUE REALICE SU FUNCIÓN EN CUALQUIER POSICIÓN DE LA CÚPULA Y SIN REGULACIÓN ALGUNA.

THE REINFORCEMENT MECHANISM DESIGNED BY **PUIG** GIVES AN EXTRAORDINARY RIGIDITY TO THE SCREEN. ONCE IT IS MOUNTED, AND UNLIKE OTHER SYSTEMS, IT IS NOT NECESSARY TO LOOSEN THE NUT IN ORDER TO MOVE THE SCREEN. THIS MECHANISM IS DESIGNED IN ORDER TO SERVE ITS FUNCTION IN ANY POSITION OF THE SCREEN AND WITHOUT NEEDING FURTHER REGULATION.